

Nombre:

5 AÑOS

PERTENECE

Estos repollos pertenecen al huerto de Víctor.

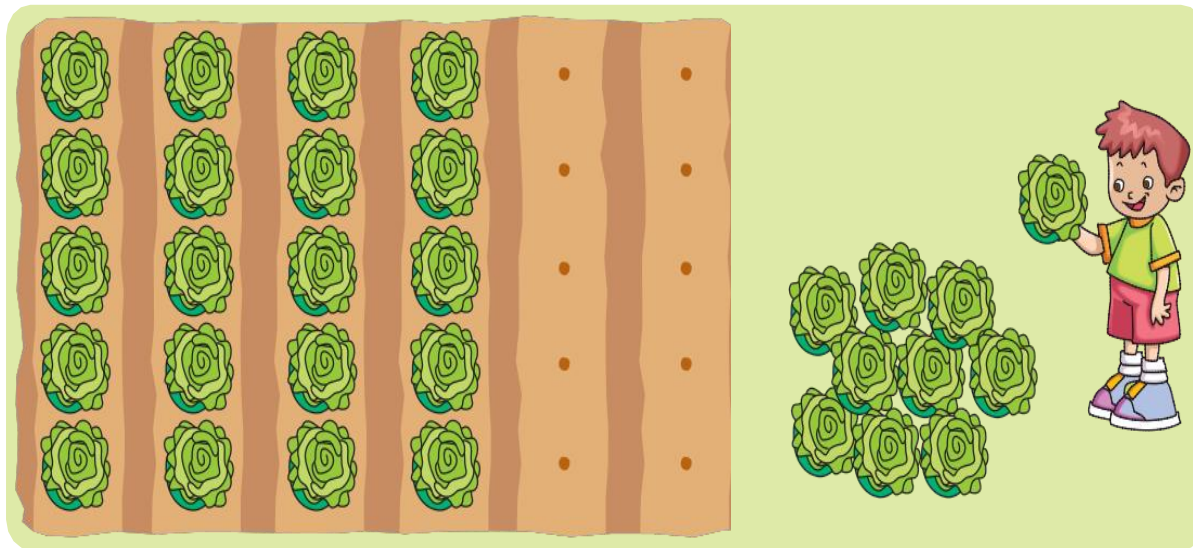

Estas manzanas pertenecen a la caja.

- Recorta y sigue llenando.

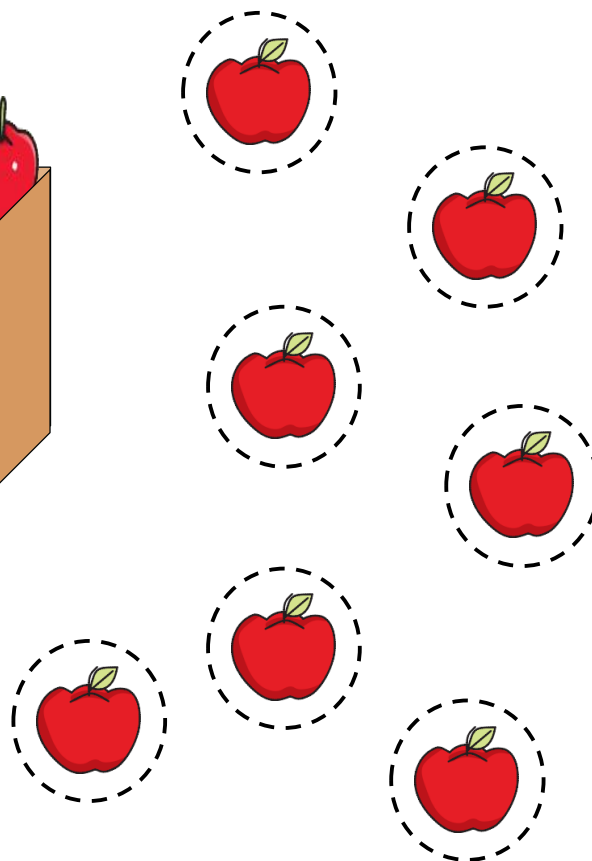
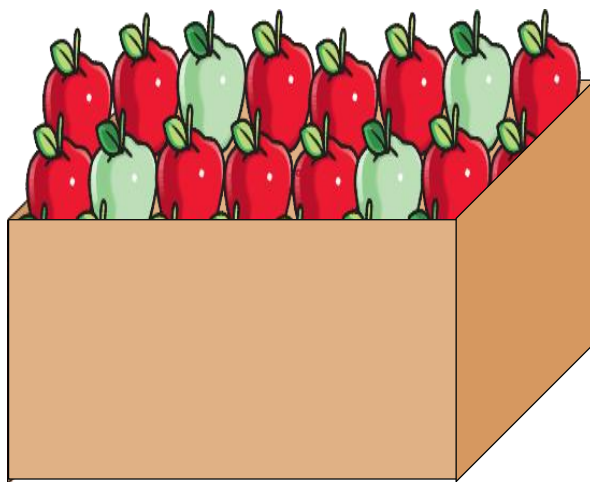

Nombre:

5 AÑOS

PERTENECE



Une con una fecha al grupo que pertenece

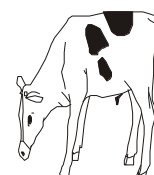
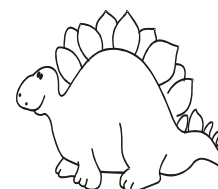
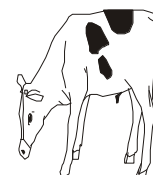
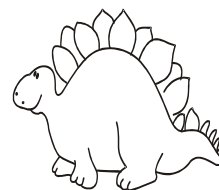
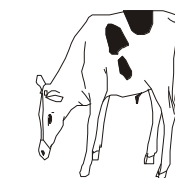
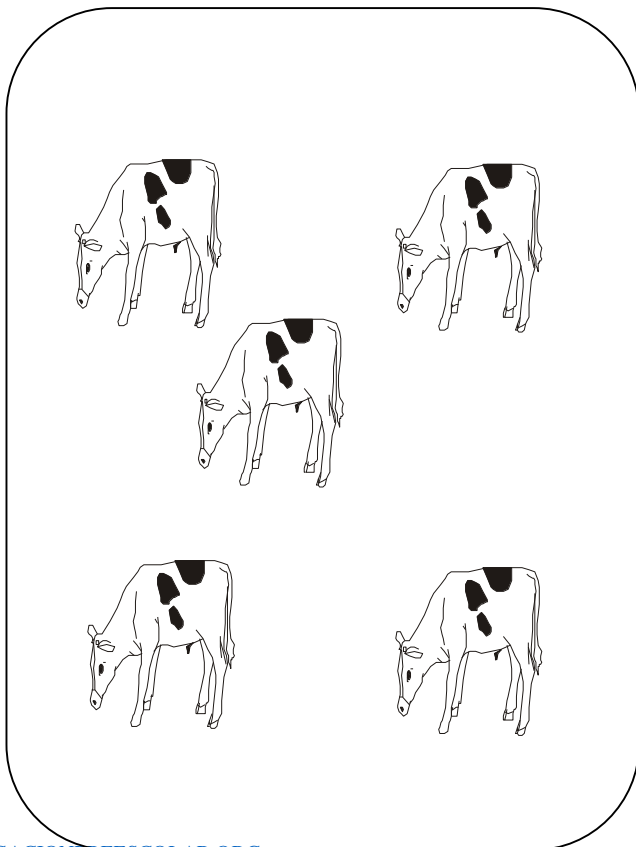
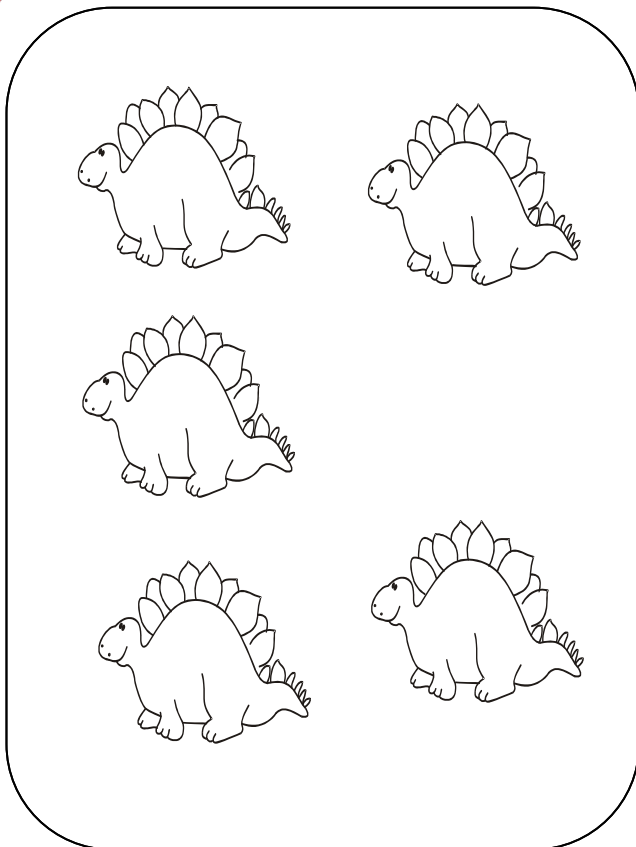

Nombre:

5 AÑOS



* Pinta los elementos que pertenecen al frutero y a la lonchera

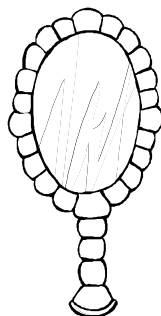
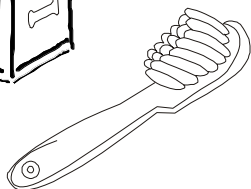
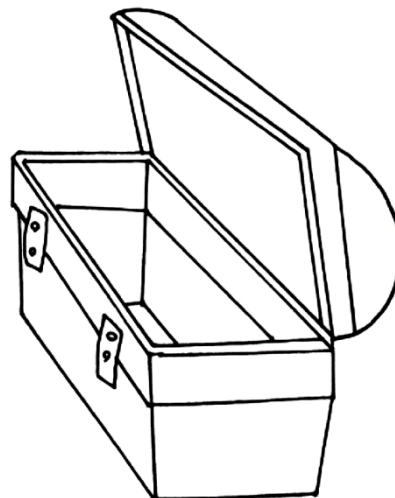
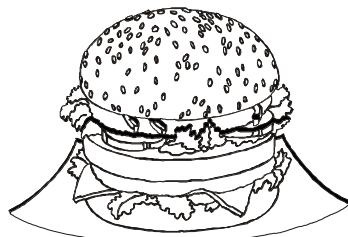
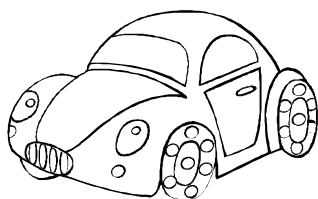
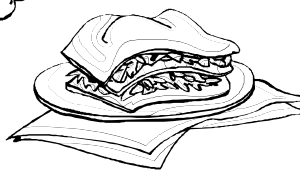
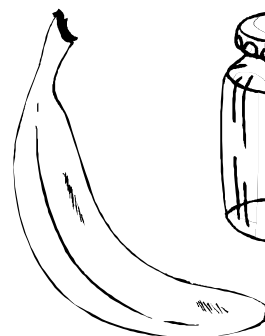
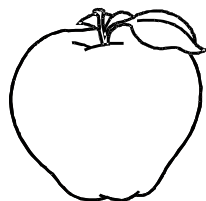
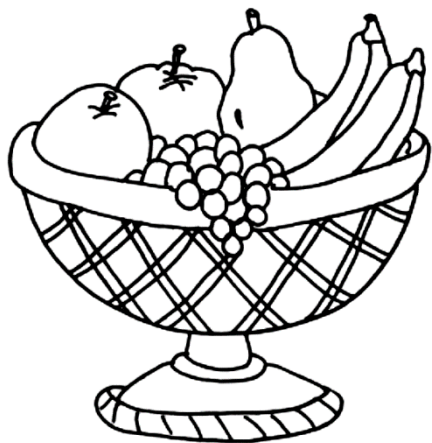

Nombre:

NO PERTENECE



Observa y aprende.
Señala con tu dedo cual no pertenece al grupo.



Señala con tu dedo el que no pertenece al grupo de cerditos.

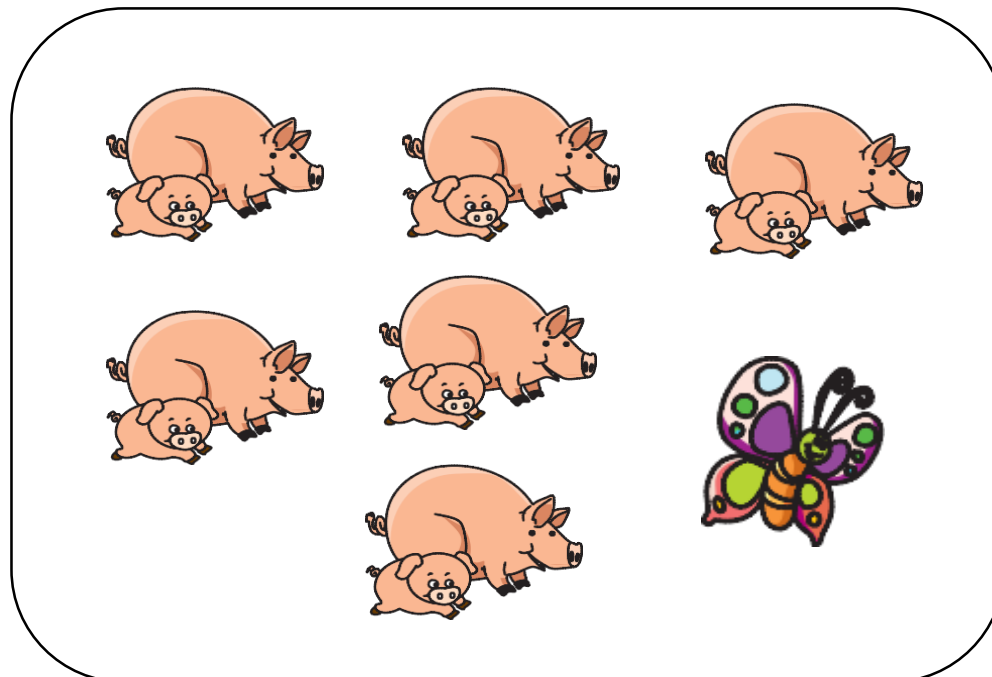

Nombre:

5
AÑOS

NO PERTENECE



Pinta el que no pertenece al grupo.

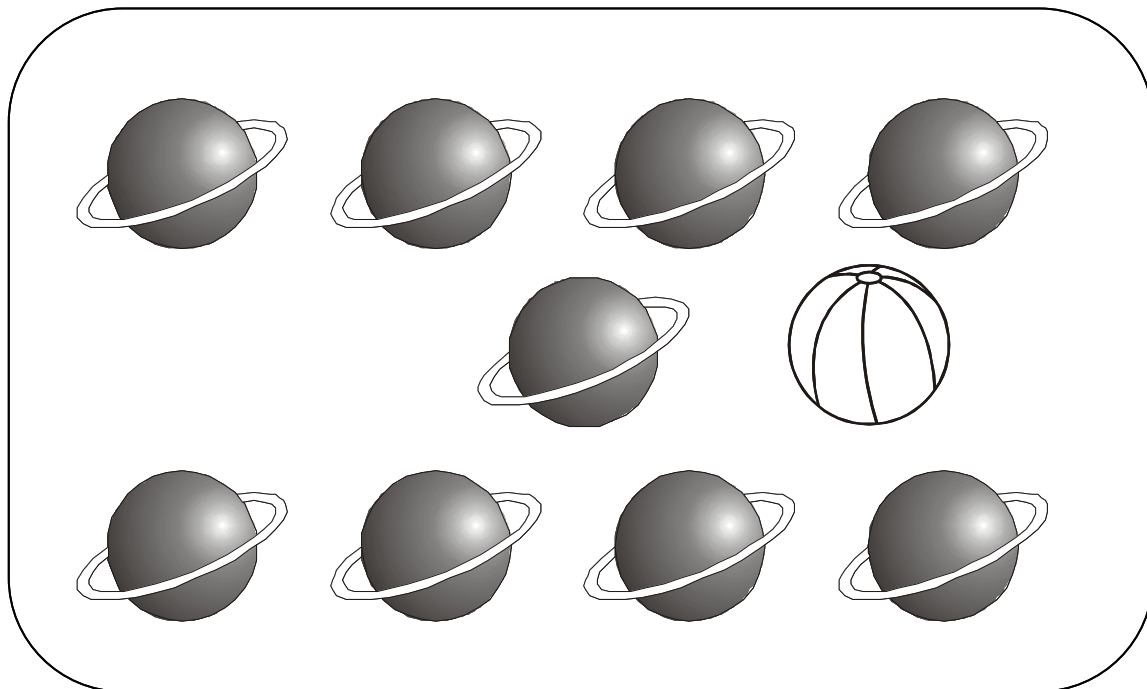
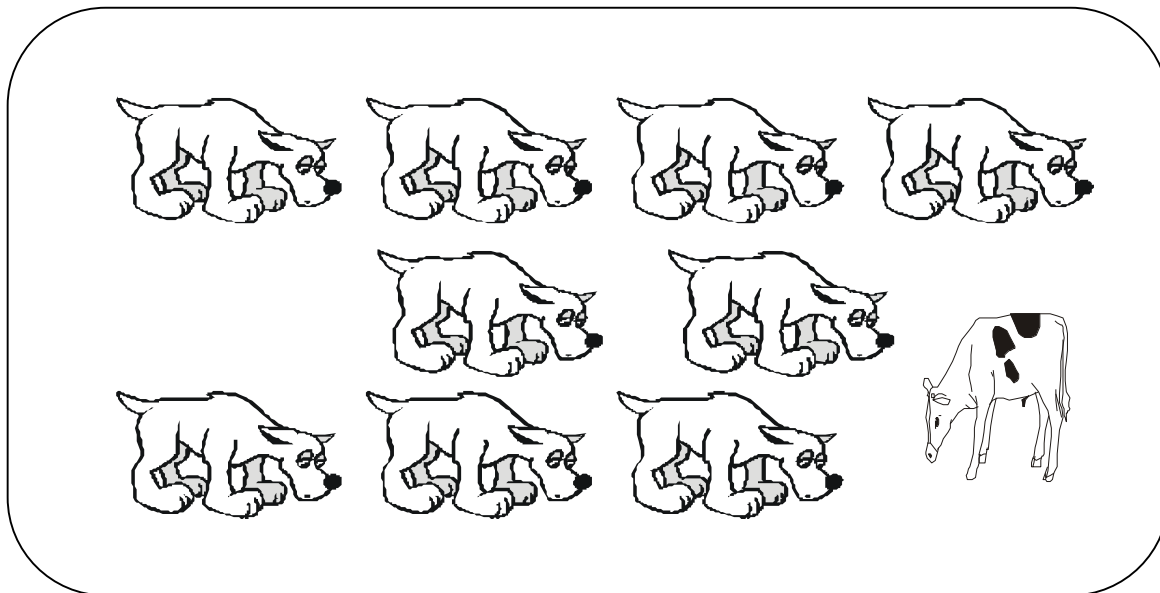

Nombre:

5 AÑOS



Pinta los objetos que no pertenecen

